

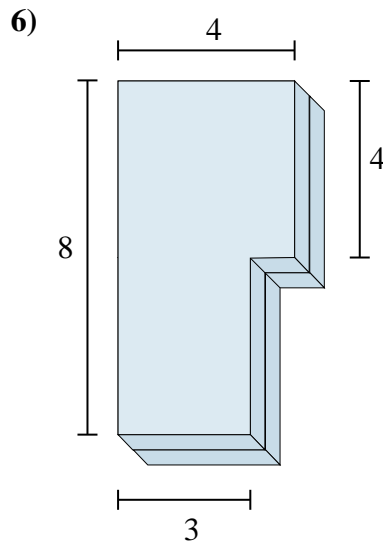

Find the total volume of each figure shown. Measured in cm (not to scale).

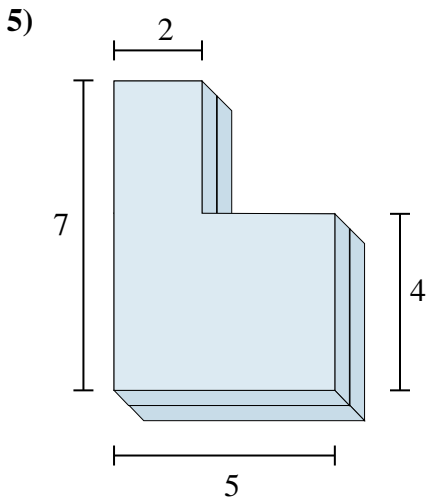
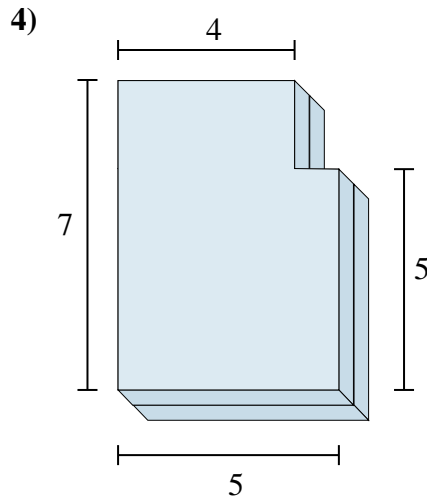
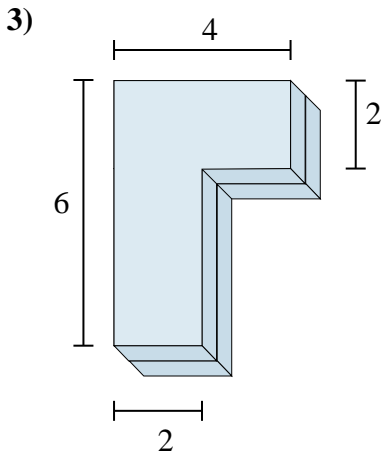
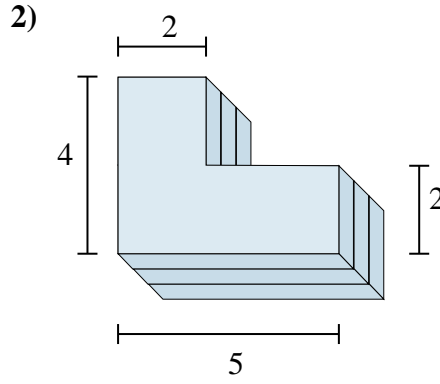
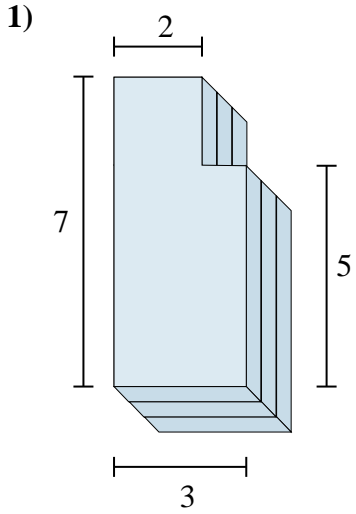

Answers

1. _____
2. _____
3. _____
4. _____
5. _____
6. _____



Find the total volume of each figure shown. Measured in cm (not to scale).

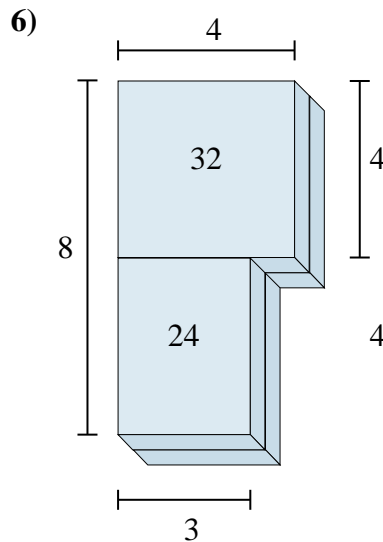
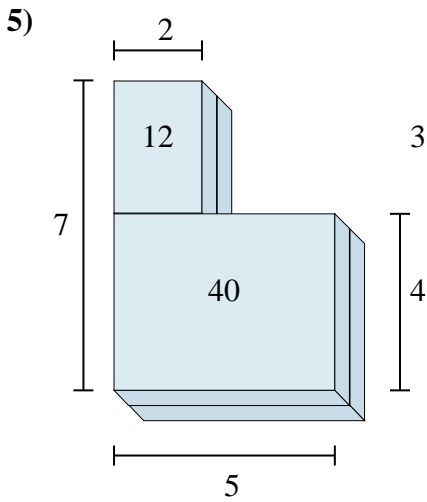
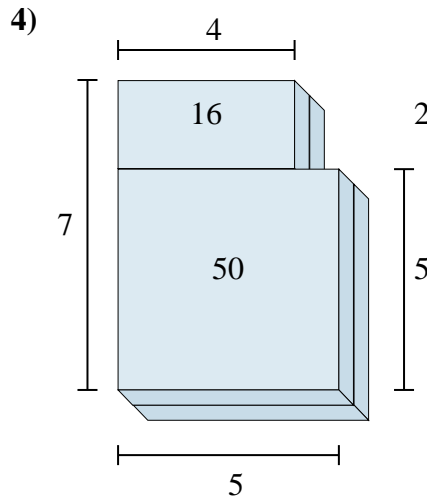
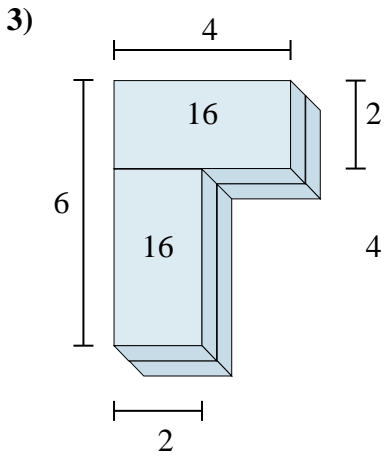
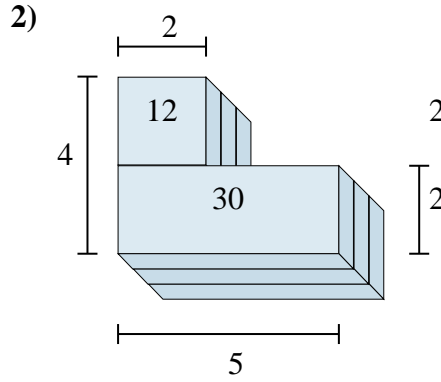
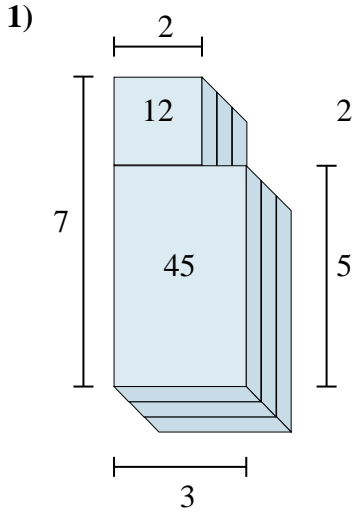

Answers

1. 57 cm³
2. 42 cm³
3. 32 cm³
4. 66 cm³
5. 52 cm³
6. 56 cm³



Find the total volume of each figure shown. Measured in cm (not to scale).

Answers

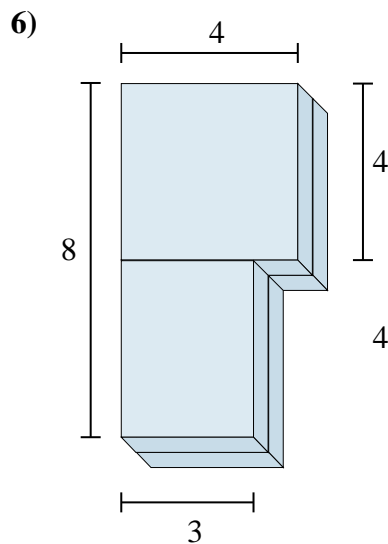
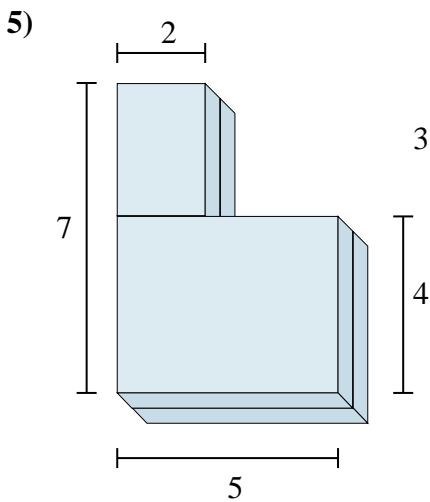
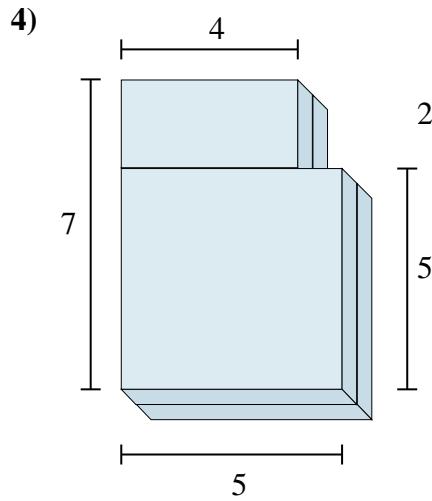
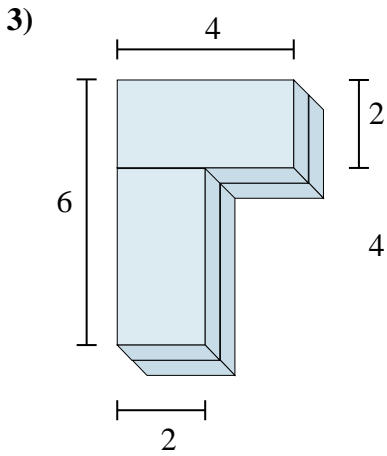
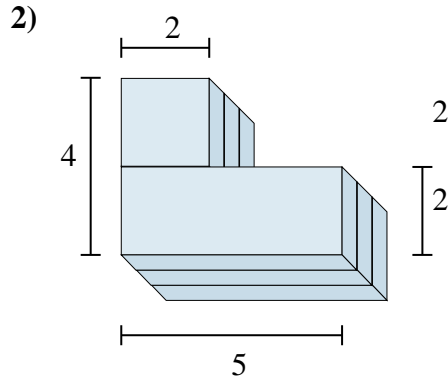
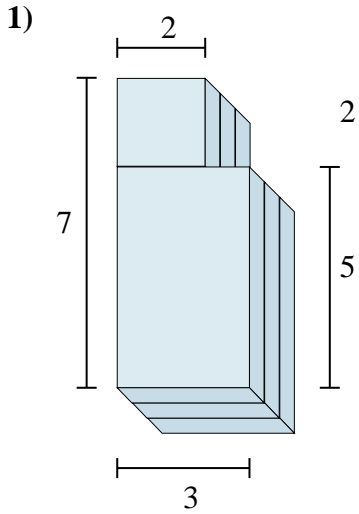

1. _____
2. _____
3. _____
4. _____
5. _____
6. _____